

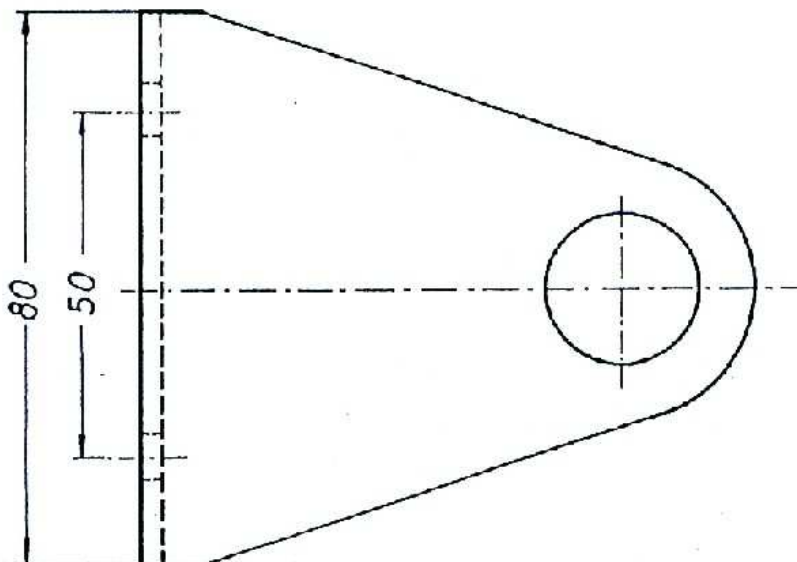

BEVESTIGINGSHOEK MWI 90 / 120
MONTAGEHOUDER VOOR OLIEDRUPPELAAR
SUPPORT MWI 90 / 120
POUR DES GOUTTEURS

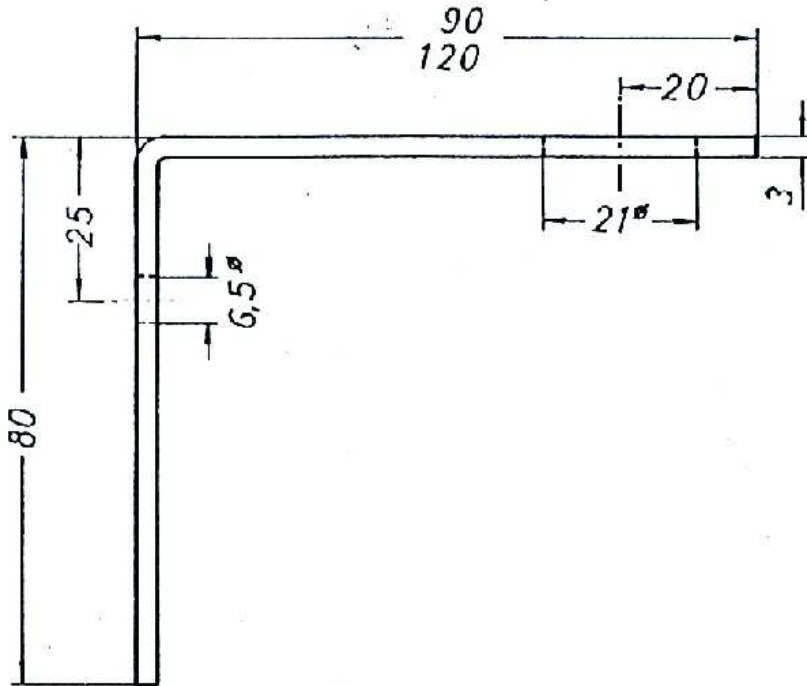

Montagehoek voor / Support pour:

UNI	60 – 150x180
UST	60 – 100x120
MOS	140 – 3000
MTM	140 – 3000
OBH	500 – 3000
ELO	140 – 3000
MET	140 – 3000
EOS	140 – 3000
EPO	500 – 3000
	≤ 1000 ml MWI 90
	≥ 2000 ml MWI 120

Alle uitvoeringen onder voorbehoud van wijzigingen.
Sous réserve de modifications.



BORSTELHOUDERS - TOEBEHOREN ACCESSOIRES – SUPPORTS DES PINCEAUX

PHA STALEN BORSTELHOUDER / SUPPORT DE PINCEAU EN ACIER

In de hoogte verstelbaar door schroefdraad / Réglable en hauteur par filet de vis

Art nr.	A	B	Draad
Nr. de comm.			Filetage
PHA 60	60	47	G 1/8
PHA 80	80	47	G 1/8
PHA 120	120	47	G 1/8

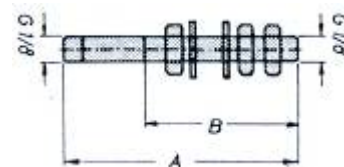

PHA STALEN BORSTELHOUDER / SUPPORT DE PINCEAU EN ACIER

In de hoogte verstelbaar door klemmechanisme - Draaibaar, ter bevestiging op een montagerail
Réglable en hauteur par mécanisme de pince - Tournable, pour installer sur un rail de montage

Art. nr.	A	B	Draad
Nr. de comm.			Filetage
PHB 60	60	30	G 1/8
PHB 80	80	30	G 1/8
PHB 120	120	30	G 1/8

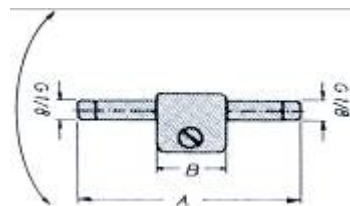

PHC STALEN BORSTELHOUDER / SUPPORT DE PINCEAU EN ACIER

Vaste uitvoering in klemmechanisme – regelbare hoogte
Version fixe dans un mécanisme de pince – hauteur réglable

Art. nr.	A	B	Draad
Nr. de comm.			Filetage
PHC 60	60	30	G 1/8
PHC 80	80	30	G 1/8
PHC 120	120	30	G 1/8

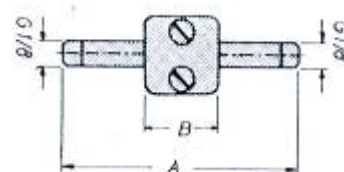

BEVESTIGINGSPROFIEL EQUERRE DE FIXATION

Voor PHA / Pour PHA



MONTAGERAIL TS 11 RAIL DE MONTAGE TS 11

Voor PHB en PHC / Pour PHB et PHC

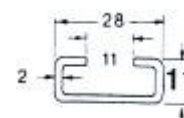

KOPPELING MET BINNENDRAAD VOOR BORSTELHOUDER

RACCORDS AVEC FILETAGE INTERIEUR

Bestelnr – N° de commande	G	Ø
D.GAV.6LG02 (recht-droit)	1/8	6
D.WAV.6LG02 (haaks-coudé)	1/8	6

Ø 6 mm



KOPPELING VOOR BORSTELHOUDER RACCORDS POUR SUPPORT DES PINCEAUX

Bestelnr – N° de commande	G	Ø
CK.GE.04LLR02	1/8	4
CK.WE.04LLR02	1/8	4
FI.270.2XR02M	1/8	

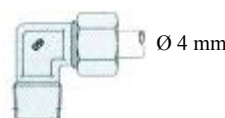
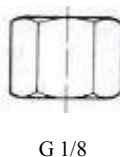







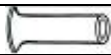
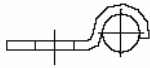
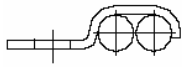
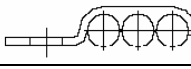
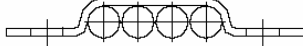

Alle uitvoeringen onder voorbehoud van wijzigingen
Sous réserve de modifications

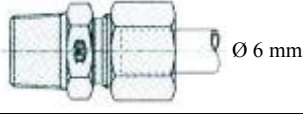

TOEBEHOREN VOOR OLIEDRUPPELAARS EN BORSTELS

LEIDINGEN, KOPPELINGEN EN TOEBEHOREN TOT AAN HET LAGER

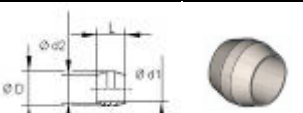
Pos.	Qua.	Bestelnummer	Artikel	
1		LPA.HNF.06/04	Polyamide-leiding 6x1.TR6/4 transparant	
2		LME.ST-G.06/04	Staalbuis gegalvaniseerd 6/4, 389 bar, DIN 2391C	
3		LME.CU.06/04	Koperbuis 6/4, 100 bar	
4		LPA.E.05-6/4	Insteekhuls (verplicht voor koppeling met PA)	
5		LB.LK.01X06	Leidingklem gegalvaniseerd, 1 x 6 mm	
6		LB.LK.02X06	Leidingklem gegalvaniseerd, 2 x 6 mm	
7		LB.LK.03X06	Leidingklem gegalvaniseerd, 3 x 6 mm	
8		LB.LK.04X06	Leidingklem gegalvaniseerd, 4 x 6 mm	
9		LB.LK.RS-16-12	Gegalvaniseerde leidingklemmen met rubber Ø leiding 6 mm	
10		LB.LK.TF4	Kabelbinders in plastic max. Ø 31.4 mm	
11		LB.LK.TF5	Kabelbinders in plastic max. Ø 44.4 mm	
12		LB.LK.TF7	Kabelbinders in plastic max. Ø 88.9 mm	
13		VBM. ZTV.BM04X08	Zelftappende vijs voor klemmen M 4 x 8 mm (3.5 mm boren)	
14		CK.GE.06LLM06X1	Rechte inschroefkoppeling konisch 6x1	
15		CK.GE.06LLM08X1	Rechte inschroefkoppeling konisch 8x1	
16		CK.GE.06LLM10X1	Rechte inschroefkoppeling konisch 10x1	
17		CK.GE.06LLR02	Rechte inschroefkoppeling konisch 1/8"	
18		CK.GE.06LR04	Rechte inschroefkoppeling konisch 1/4"	
19		CK.WE.06LLM06X1	Haakse inschroefkoppeling konisch 6x1	
20		CK.WE.06LLM08X1	Haakse inschroefkoppeling konisch 8x1	
21		CK.WE.06LLM10X1	Haakse inschroefkoppeling konisch 10x1	
22		CK.WE.06LLR02	Haakse inschroefkoppeling konisch 1/8"	
23		CK.WE.06LR04	Haakse inschroefkoppeling konisch 1/4"	
24		D.GAV.6LG02	Koppelingen met binnendraad voor borstelhouder (recht) G: 1/8	
25		D.WAV.6LG02	Koppelingen met binnendraad voor borstelhouder (haaks) G: 1/8	
26		LK.KR.ME-06	Knelring messing Ø 6 mm L= 6.5 mm	
27		LK.KR.ME-06	Knelring messing Ø 6 mm L= 6.5 mm	

De meeste onderdelen zijn ook verkrijgbaar in inox

Op aanvraag: detailafmetingen, andere Ø of koppelingen in messing of inox.

Alle uitvoeringen onder voorbehoud van wijzigingen