

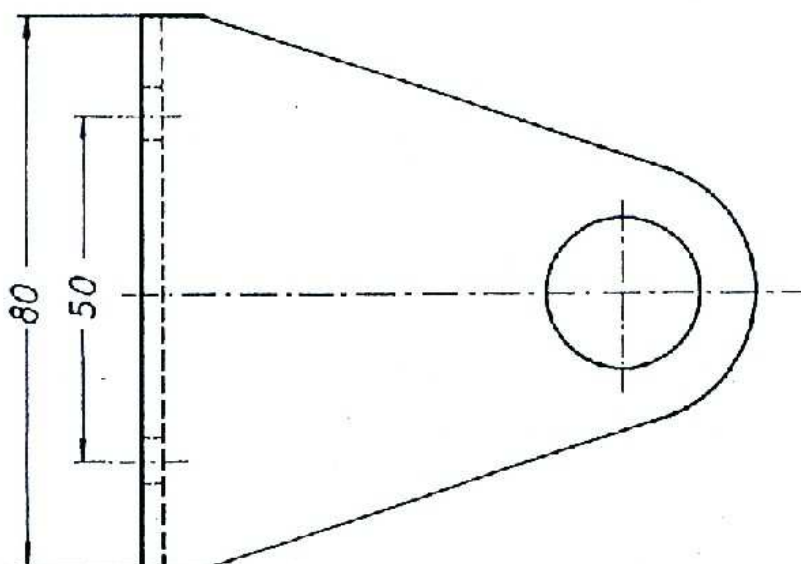

**BEVESTIGINGSHOEK MWI 90 / 120**  
**MONTAGEHOUDER VOOR OLIEDRUPPELAAR**  
*SUPPORT MWI 90 / 120*  
*POUR DES GOUTTEURS*

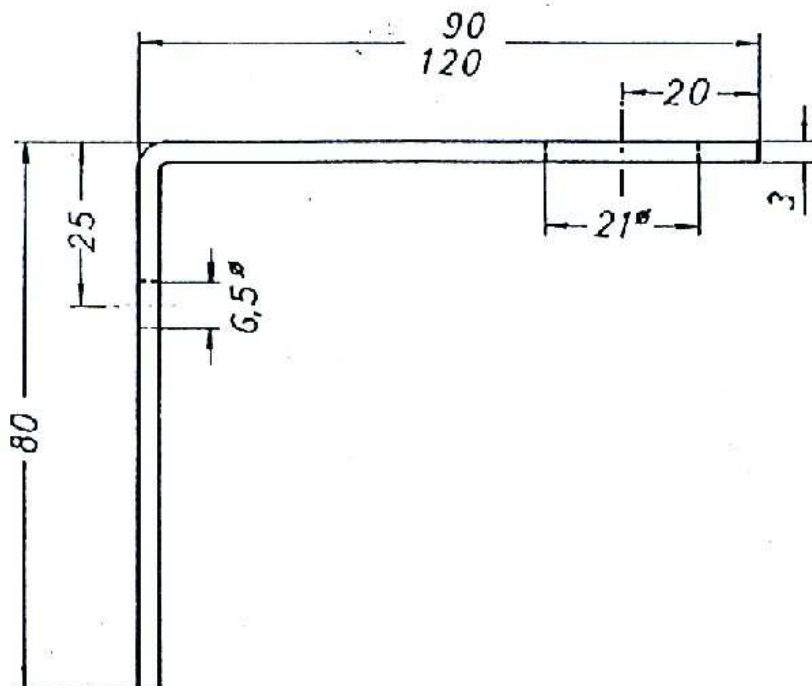

Montagehoek voor / Support pour:







UNI	60 – 150x180
UST	60 – 100x120
MOS	140 – 3000
MTM	140 – 3000
OBH	500 – 3000
ELO	140 – 3000
MET	140 – 3000
EOS	140 – 3000
EPO	500 – 3000
	≤ 1000 ml MWI 90
	≥ 2000 ml MWI 120

Alle uitvoeringen onder voorbehoud van wijzigingen.  
Sous réserve de modifications.

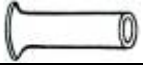
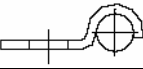
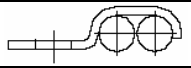
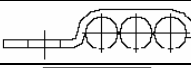
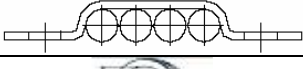

## ACCESSOIRES POUR DES GOUTTEURS et DES PINCEAUX

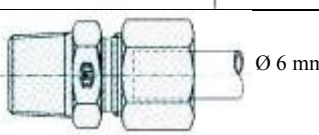
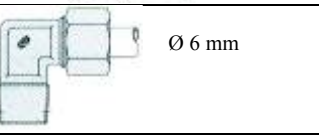
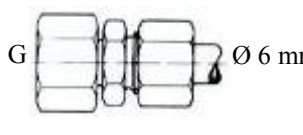
TUYAUX, RACCORDS ET ACCESSOIRES JUSQU'AU PALIER

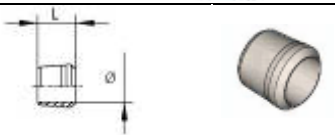
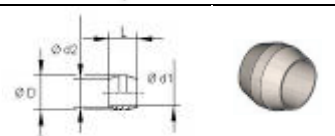
Pos.	Qu an.	N° de commande	Article	
1		LPA.HNF.06/04	Tuyaux de polyamide (PA) 6x1 TR6/4 transparent	
1		LME.ST-G.06/04	Tuyau acier galvanises 6/4, 389 bar, DIN 2391C	
2		LME.CU.06/04	Tuyau en cuivre 6/4, 100 bar	
3		LPA.E.05-6/4	Douille d'insertion (obliger pour raccordement avec tuyau en PA ou polyamide)	
4		LB.LK.01X06	Bride de tuyau galvanises, 1 x 6 mm	
5		LB.LK.02X06	Bride de tuyau galvanises, 2 x 6 mm	
6		LB.LK.03X06	Bride de tuyau galvanises, 3 x 6 mm	
7		LB.LK.04X06	Bride de tuyau galvanises, 4 x 6 mm	
8		LB.LK.RS-16-12	Brides de tuyaux galvanises avec caoutchouc Ø tuyau 6 mm	
9		LB.LK.TF4	Collier de câble en plastique max. Ø 31.4 mm	
10		LB.LK.TF5	Collier de câble en plastique max. Ø 44.4 mm	
11		LB.LK.TF7	Collier de câble en plastique max. Ø 88.9 mm	
12		VBM. ZTV.BM04X08	Vis autoradeuse pour brides M 4 x 8 mm (percer 3.5 mm)	
13		CK.GE.06LLM06X1	Raccord union mâle conique 6x1	
14		CK.GE.06LLM08X1	Raccord union mâle conique 8x1	
15		CK.GE.06LLM10X1	Raccord union mâle conique 10x1	
16		CK.GE.06LLR02	Raccord union mâle conique 1/8"	
17		CK.GE.06LR04	Raccord union mâle conique 1/4"	
18		CK.WE.06LLM06X1	Raccord coudé mâle conique 6x1	
19		CK.WE.06LLM08X1	Raccord coudé mâle conique 8x1	
20		CK.WE.06LLM10X1	Raccord coudé mâle conique 10x1	
21		CK.WE.06LLR02	Raccord coudé mâle conique 1/8"	
22		CK.WE.06LR04	Raccord coudé mâle conique 1/4"	
23		D.GAV.6LG02	Raccord droit avec filetage intérieur G: 1/8	
24		D.WAV.6LG02	Raccord coudé avec filetage intérieur G: 1/8	
25		LK.KR.ME-06	Knelring messing Ø 6 mm L= 6.5 mm	
26		LK.KR.ME-06	Knelring messing Ø 6 mm L= 6.5 mm	

Les plus part des accessoires sont disponible en inox.

Sur demande: des mesures détaillées, autres Ø et raccords en laiton ou inoxydable.

Sous réserve de modifications